



Mobile contenitore multifunzione in listellare e massello dotato di anta singola in vetro con angolo di apertura a 180°. L'allestimento prevede vani contenitori porta bottiglie e bicchieri, con possibilità di inserire piccoli elettrodomestici (nella versione Jumbo). L'interno del mobile è illuminato per mezzo di una striscia a LED posizionata sulla spalla esterna, la cui accensione risulta automatica tramite sensore che si attiva all'apertura dell'anta.

APERTURA ANTA DA SPECIFICARE

PER VERSIONE JUMBO (con possibilità di inserimento piccoli elettrodomestici da incasso quali frigo, forno microonde, cantina vini): il vano è pensato per elettrodomestici con misure di incasso massimo L.56 P.55 H.91.5 cm, realizzabile su misura a richiesta. Necessario invio della scheda tecnica dell'elettrodomestico selezionato per verifica tecnica.

COD.	MISURE	ANTA	A1	A2	A4
<b>CAMBUSA WINE GLASS SMALL</b>	L.77/154,5 x P.60,4 x H.201	E1	■	■	■
		E2	■	■	■
<b>CAMBUSA WINE GLASS SMALL JUMBO</b>	L.77/154,5 x P.78,9 x H.201	E1	■	■	■
		E2	■	■	■

**FINITURE DISPONIBILI:**

**A1:** noce senza nodi, noce con nodi

**A2:** rovere senza nodi, rovere con nodi, ciliegio

**A4:** rovere senza nodi pigmentato: bianco latte, total black  
 rovere con nodi pigmentato: bianco latte, total black

**E1:** vetro: trasparente / extra chiaro, satinato

**E2:** vetro: fumé, bronzato

# CAMBUSA WINE GLASS SMALL / JUMBO

CAMBUSA WINE GLASS SMALL JUMBO

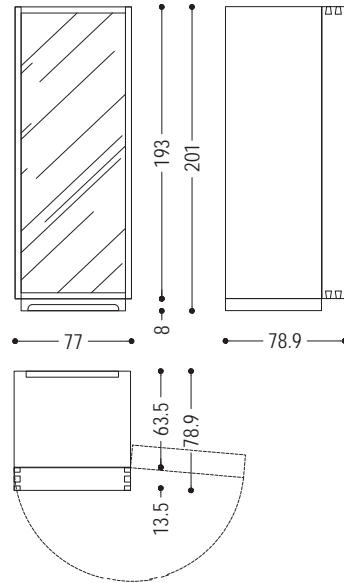

VANO PER CANTINA VINI DA INCASSO



CAMBUSA WINE GLASS SMALL

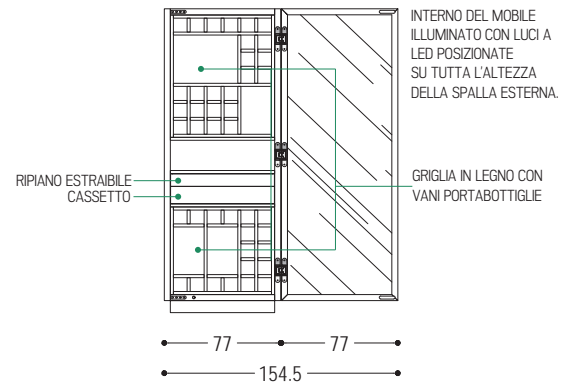
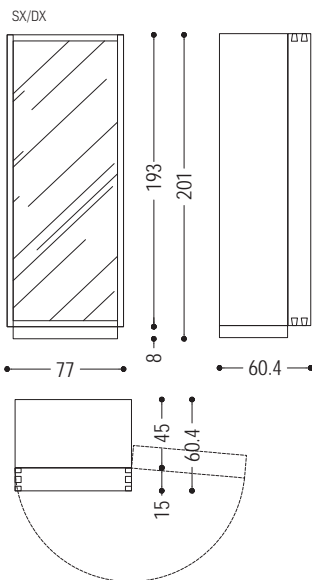

# CAMBUSA WINE GLASS SMALL /JUMBO | FINITURE DISPONIBILI

## LEGNO

A1

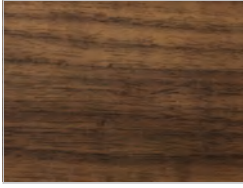

noce senza nodi



noce con nodi

A2

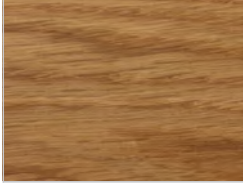

rovere senza nodi



rovere con nodi

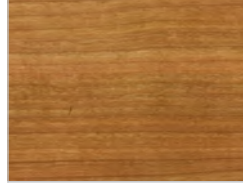

ciliegio

A4



rovere senza nodi pigmentato:  
bianco latte

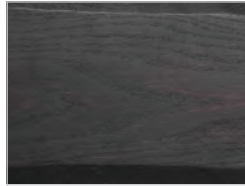

rovere senza nodi pigmentato:  
total black



rovere con nodi pigmentato:  
bianco latte



rovere con nodi pigmentato:  
total black

## FERRO

B2

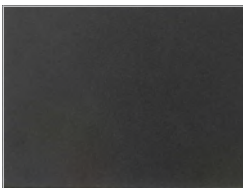

ferro laccato:  
iron dust

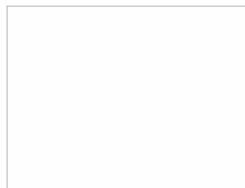

ferro laccato:  
RAL - 1013\_BIANCO PERLA

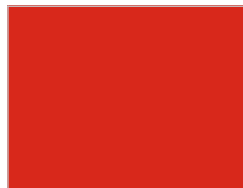

ferro laccato:  
RAL - 3020\_ROSSO TRAFFICO

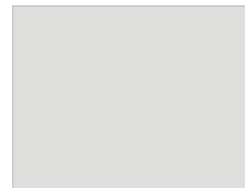

ferro laccato:  
RAL - 7035\_GRIGIO LUCE

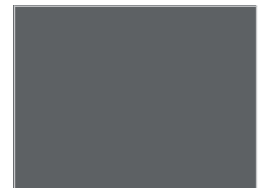

ferro laccato:  
RAL - 7037\_GRIGIO POLVERE

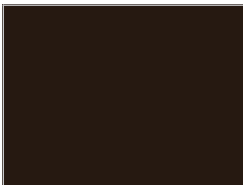

ferro laccato:  
RAL - 8019\_MARRONE GRIGIASTRO

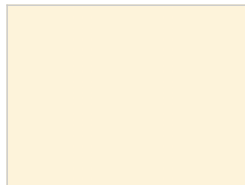

ferro laccato:  
RAL - 9001\_BIANCO CREMA

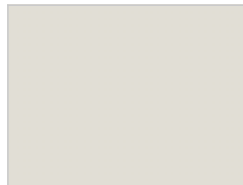

ferro laccato:  
RAL - 9002\_BIANCO GRIGIASTRO

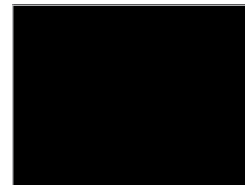

ferro laccato:  
RAL - 9005\_NERO INTENSO

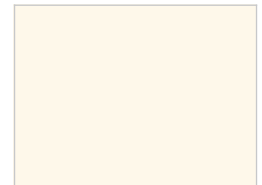

ferro laccato:  
RAL - 9010\_BIANCO PURO



ferro laccato:  
RAL - 9016\_BIANCO TRAFFICO

# CAMBUSA WINE GLASS SMALL /JUMBO | FINITURE DISPONIBILI

B3

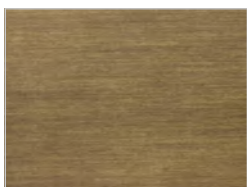

ferro laccato effetto spazzolato opaco:  
bronzo antico

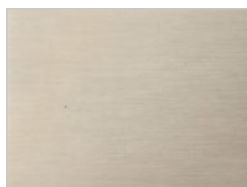

ferro laccato effetto spazzolato opaco:  
acciaio

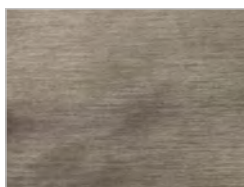

ferro laccato effetto spazzolato opaco:  
titanio



ferro laccato effetto ossidato

## VETRO

E1



vetro trasparente / extra chiaro

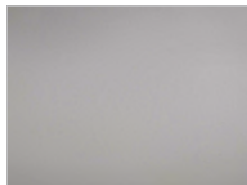

vetro satinato

E2

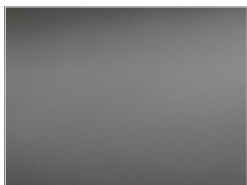

vetro FUMÉ



vetro BRONZATO