

Contents

1	Instructions	42
1.1	General safety instructions	42
1.2	Appliance purpose	46
1.6	Disposal	46
1.7	How to read the user manual	47
2	Description	48
2.1	General description	48
2.2	Control panel	49
3	Use	51
3.1	Instructions	51
3.2	Preliminary operations	52
3.3	Using the hob	52
3.4	Additional functions	60
3.5	Special functions	63
3.6	Settings menu	64
3.7	User menu	66
3.8	Error codes	69
4	Cleaning and maintenance	70
4.1	Instructions	70
4.2	Cleaning the surfaces	70
4.3	Ordinary weekly cleaning	70
4.4	Food stains or residues	70
4.5	What to do if...	71
5	Installation	72
5.1	Electrical connection	72
5.2	Instructions for the installer	73
5.3	Safety instructions	73
5.4	Power limitation	74
5.5	Section cut from the countertop	74
5.6	Mounting	75

TRANSLATION OF THE ORIGINAL INSTRUCTIONS

These instructions apply only for the destination countries listed on the appliance's data plate. This is a class 3 built-in hob.

We advise you to read this manual carefully, which contains all the instructions for maintaining the appliance's aesthetic and functional qualities. For further information on the product: www.smeg.com



Instructions

1 Instructions

1.1 General safety instructions

Risk of personal injury

- During use the appliance and its accessible parts become very hot.
- Never touch the heating elements during use.
- Protect your hands by wearing heat-proof gloves during use.
- Never try to put out a fire or flames with water: Turn off the appliance and smother the flames with a fire blanket or other appropriate cover.
- This appliance may be used by children aged at least 8 and by people of reduced physical, sensory or mental capacity, or lacking in experience in the use of electrical appliances, provided that they are supervised or instructed by adults who are responsible for their safety.
- Children must not play with the appliance.
- Keep children under the age of eight at a safe distance unless they are constantly supervised.
- Keep children under the age of 8 away from the appliance when it is in use.
- Cleaning and maintenance must not be carried out by unsupervised children.
- Be aware of how rapidly the cooking zones heat up. Do not let pans heat up when dry, as there is a danger of them overheating.
- Fats and oils can catch fire if they overheat. Do not leave the appliance unattended while preparing foods containing oils or fats. If fats or oils catch fire, never put water on them. Place the lid on the pan and turn off the relevant cooking zone.
- Do not use the Booster and Double Booster functions to heat fats or oils. Fire hazard.
- Place the cookware directly on the glass ceramic. Do not put any papers, cloths or trivets beyond the pot. Risk of burning!
- The cooking process must always be monitored. A short cooking process must be continuously monitored.
- Do not place metal objects, such as dishes or cutlery, on the hob surface during use as they may overheat.
- Do not insert pointed metal objects (cutlery or utensils) into the slots in the appliance.
- Do not pour water directly onto very hot trays.



- Do not use or store flammable materials near the appliance or directly underneath the hob.
- **DO NOT USE AEROSOLS IN THE VICINITY OF THIS APPLIANCE WHILST IT IS IN USE.**
- Switch off the appliance immediately after use.
- **DO NOT MODIFY THIS APPLIANCE.**
- Always use any necessary/required personal protective equipment (PPE) before performing any work on the appliance (installation, maintenance, positioning or movement).
- Before performing any work on the appliance, switch off the power supply.
- Installation and servicing should be carried out by qualified personnel in accordance with current standards.
- Do not try to repair the appliance yourself or without the assistance of a qualified technician.
- If the power supply cable is damaged, contact technical support immediately and they will replace it.

Risk of damaging the appliance

- Do not use abrasive or corrosive detergents (e.g. scouring powders, stain removers and metallic sponges) on glass parts.
- Use wooden or plastic utensils.
- Do not sit on the appliance.
- Do not use the hob as a support surface.
- Do not obstruct ventilation openings and heat dispersal slots.
- Do not use steam jets to clean the appliance.
- The cookware's bottom should be as even as possible. An air gap (e. g. stamped imprints with the manufacturer's logo in the center point) may cause damages (e. g. deformed bottom surfaces due to overheating).
- Never leave the appliance unattended during cooking operations where fats or oils could be released, as these could then heat up and catch fire. Be very careful.
- Fire hazard: Never leave objects on the cooking surfaces.
- **DO NOT FOR ANY REASON USE THE APPLIANCE AS A SPACE HEATER.**
- Cooking vessels or griddle plates should be placed inside the perimeter of the hob.



Instructions

- All pans must have smooth, flat bottoms.
- If any liquid does boil over or spill, remove the excess from the hob.
- Take care not to spill acid substances such as lemon juice or vinegar on the hob.
- Do not spill sugar or sweet mixtures on the hob during cooking.
- Do not place materials or substances that could melt or catch fire (paper, plastic or aluminium foil) on the appliance while it is in use.
- Place the cookware directly on the glass ceramic surface.
- Do not put empty pans or frying pans on switched on cooking zones.
- Do not use rough or abrasive materials or sharp metal scrapers.
- Do not use cleaning products containing chlorine, ammonia or bleach on parts made of steel or that have metallic surface finishes (e.g. anodizing, nickel- or chromium-plating).

Installation

- THIS APPLIANCE **MUST NOT BE INSTALLED** IN BOATS OR CARAVANS.
- Position the appliance into the cabinet cut-out with the help of a second person.
- Check that the carcass material is heat resistant.
- Check that the carcass has the required openings.
- To avoid potential overheating, the appliance must not be installed behind a decorative door or a panel.
- Have the electrical connection performed by authorised technical personnel.
- Use a flexible and heat-resistant connection cord. Apply wire end ferrules to the cable ends before connecting them to the generator.
- The appliance must be connected to earth in compliance with electrical system safety standards.
- Use cables that can withstand temperatures of at least 90 °C.
- The tightening torque of the screws of the terminal supply wires must be 1.5 - 2 Nm.
- The power cable must only be installed or replaced by a qualified technician.



For this appliance

- If cracks or fissures form, or if the glass ceramic cooking surface breaks, turn off the appliance immediately. Disconnect the power supply and call Technical Support.
- Avoid hard, solid objects falling on the cooking surface.
- Do not use the hob if the pyrolytic cycle is taking place inside any oven installed below.
- Do not touch or clean the hob surface during operation or when the residual heat indicator lights are still on.
- Activate the controls lock when you have children or pets which could reach the hob.
- After use the cooking zones remain hot for a certain period of time after they have been turned off. Do not touch the hob surfaces.
- After use, switch off the plates. Never rely solely on the cookware detector.
- Do not use the glass ceramic cooking surface as a support surface.
- Remove any traces of liquid from the cover (if fitted) before opening.
- Supervise children carefully as they cannot readily see the residual heat indication. After use the cooking zones remain hot for a certain period of time even if they have been turned off. Keep children away from the cooking zones.
- The glass ceramic surface is highly resistant to impact. However, prevent hard, solid objects from falling on the cooking surface as they may cause it to break if they are sharp.
- Let the cooking surface cool down before closing the cover.
- People who have pacemakers or other similar devices fitted must make sure that the operation of these devices is not affected by the induction field, the frequency range of which is between 20 and 50 kHz.
- In conformity with the provisions regarding electromagnetic compatibility, the electromagnetic induction cooking hob comes under group 2 and class B (EN 55011).



Instructions

- This appliance complies with the current standards and directives regarding safety and electromagnetic compatibility. It is however recommended for pacemaker wearers to maintain a minimum distance of 20-30 cm between the appliance when it is operating and the pacemaker. Consult the pacemaker manufacturer for more information.

1.2 Appliance purpose

- This appliance is intended for cooking food in the home environment. Every other use is considered improper.
- The appliance is not designed to operate with external timers or with remote-control systems.

1.3 Manufacturer's liability

- The manufacturer declines all liability for damage to persons or property caused by:
- Use of the appliance other than that specified
- Failure to comply with the instructions in the user manual
- Tampering with any part of the appliance
- The use of non-original spare parts.

1.4 Identification plate

The identification plate bears the technical data, serial number and brand name of the appliance. Do not remove the identification plate for any reason.

1.5 This user manual

This user manual is an integral part of the appliance and must therefore be kept in its entirety and within the user's reach for the whole working life of the appliance.

- Read this user manual carefully before using the appliance.

1.6 Disposal



This appliance conforms to the WEEE European directive (2012/19/EU) and must be disposed of separately from other waste at the end of its service life. The appliance does not contain substances in quantities sufficient to be considered hazardous to health and the environment, in accordance with current European directives.

To dispose of the appliance:

- Cut the power supply cable and remove it along with the plug.



Power voltage

Danger of electrocution

- Disconnect the mains power supply.
- Unplug the appliance.



- Deliver the appliance to the appropriate recycling centre for electrical and electronic equipment waste, or return it to the retailer when purchasing an equivalent product, on a one for one basis.

Our appliances are packaged in non-polluting and recyclable materials.

- Deliver the packing materials to the appropriate recycling centre.



Plastic packaging Danger of suffocation

- Do not leave the packaging or any part of it unattended.
- Do not let children play with the plastic bags.

1.7 How to read the user manual

This user manual uses the following reading conventions:



Instructions

General information on this user manual, on safety and final disposal.



Description

Description of the appliance and its accessories.



Use

Information on the use of the appliance and its accessories, cooking advice.



Cleaning and maintenance

Information for proper cleaning and maintenance of the appliance.



Installation

Information for the qualified technician: Installation, operation and inspection.



Safety instructions



Information



Advice

1. Sequence of instructions for use.

- Standalone instruction.



Description

2 Description

2.1 General description

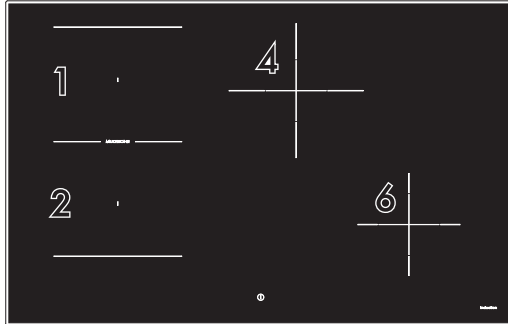

80 cm (4 cooking zones)

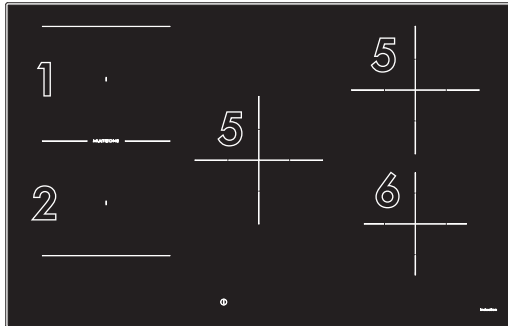

80 cm (5 cooking zones)

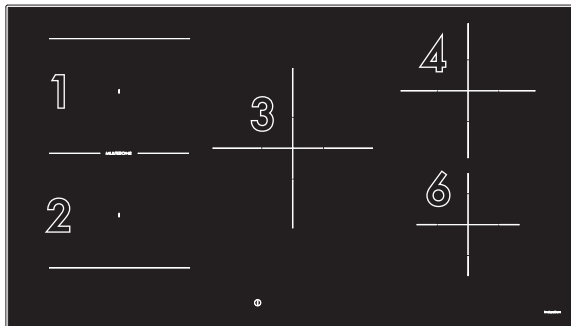

90 cm



Maximum absorbed power table (Watt)

	Dimensions H x L (mm)	Level 9	Booster	Double Booster
Zone 1/ 2: Single	180 x 218	2100	2500	3000
Zone 1/ 2: Multizone	360 x 218	1500	1850	-
Zone 3	250 x 250	2300	3000	-
Zone 4	210 x 210	2300	3000	-
Zone 5	200 x 200	2300	3000	-
Zone 6	160 x 160	1400	2100	-

Power levels are approximate and may vary according to the pan used or the settings made

2.2 Control panel

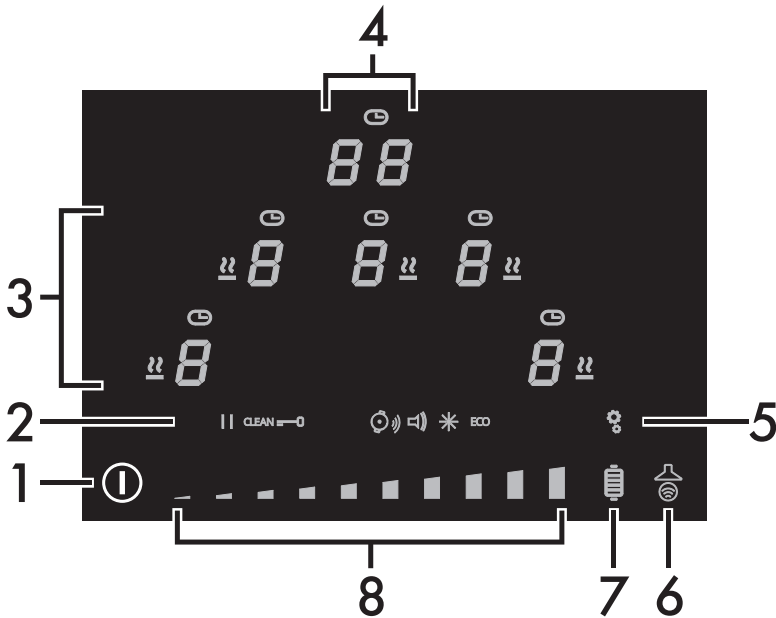

1 On/Off button

2 Settings icons

3 Cooking zone display

4 Timer display

5 Settings menu button

6 Auto-Vent 2.0 function button

7 Grill function button

8 Scroll bar



Description

Advantages of induction cooking



The appliance is equipped with an induction generator for each cooking zone. Each generator located under the glass ceramic cooking surface creates an electromagnetic field which induces a thermal current in the base of the pan. This means the heat is no longer transmitted from the hob to the pan but created directly inside the pan by the inductive current.

- Energy saving thanks to the direct transmission of energy to the pan (suitable magnetisable cookware is required) compared to traditional electric cooking.
- Improved safety as the energy is only transmitted to the pan placed on the hob.
- High level of energy transmitted from the induction cooking zone to the base of the pan.
- Rapid heating speed.
- Reduced danger of burns as the cooking surface is only heated under the base of the pan; foods which overflow do not stick.

Power control

The hob is fitted with a power control module that optimises/limits consumption. If the overall set power level exceeds the maximum limit permitted, the electronic circuit board will automatically manage the power supplied by the hot plates. The module tries to maintain the maximum deliverable power levels. Levels set by the automatic control will appear on the display.



- Priority is given to the last zone that is set.
- The power control module does not affect the total power consumption of the appliance.



3 Use

3.1 Instructions



High temperature Danger of burns

- Protect your hands by wearing heat-proof gloves during use.
- Do not touch or clean the hob surface during operation or when the residual heat indicator lights are still on.
- Do not put empty pans or frying pans on switched on cooking zones.
- Keep children under the age of 8 away from the appliance when it is in use.
- Activate the controls lock when you have children or pets which could reach the hob.
- After use the cooking zones remain hot for a certain period of time after they have been turned off. Do not touch the hob surfaces.



High temperature Danger of fire or explosion

- Do not use or leave flammable materials near the appliance or directly underneath the hob.
- Do not cook in closed tins or containers, plastic kitchenware or containers.
- Do not leave the appliance unattended during cooking operations where fats or oils could be released.
- In case you notice cracks or fissures or you cannot turn off the appliance, disconnect the power supply and contact the Assistance Centre.



Improper use Risk of damage to surfaces

- Do not use the hob if the pyrolytic cycle is taking place inside any oven installed below.
- Never place pans with bases which are not perfectly flat and smooth.
- Avoid hard, solid objects falling on the cooking surface.
- Do not use the hob as a support surface.



3.2 Preliminary operations

In order to remove any moisture that could have accumulated during the manufacturing process and for the electronic circuits and control keypad to work properly:

1. Remove the protective films from the external surfaces of the appliance and accessories.
2. Remove any labels (apart from the technical data plate).

3.3 Using the hob



All the appliance's control and monitoring devices are located together on the front panel. The induction hob is controlled by means of the Touch control sensor buttons. Lightly touch a symbol on the glass ceramic surface. A beep will sound to confirm every effective touch.

Switching on the hob for the first time











When the appliance is first connected to the mains power supply, an automatic check is carried out that momentarily switches on all the indicator lights.

When the appliance is used for the first time, after having been connected to the mains the flashing  symbol appears on the display. It is used to access the appliance's technical menu and is intended only for Technical Support personnel.





Once the appliance has been switched on, the  icon, the dimly lit  button and

the text  will appear on the timer display.

List of icons

-  Warming function icon.
-  Timer icon.
-  Pause function icon.
-  Clean function icon.
-  Controls lock icon.
-  Automatic pan detection icon.
-  Button volume icon.
-  Display brightness icon.
-  Eco mode icon.

List of buttons

-  On/Off button: turns the hob on or off.
-  Settings menu button: allows you to access the appliance's settings.
-  Grill function button: activates the Grill function
-  Auto-Vent 2.0 function button: activates communication between the hob and the extractor hood.



Scroll bar: increases or decreases the power level of a cooking zone, allows you to adjust settings and to select the user menu options.



Cooking zones display



The buttons for selecting the cooking zones and the timer icons above each of them and the Warming function icon are found in this zone.

Timer display



The controls for setting the independent timer and the timer for the cooking zones are located in this area. The following text is displayed when it is possible to set an

independent timer 

Pan diameters

Make sure that the minimum diameter of the pans is that indicated in the following table:

Zone	∅ minimum (cm)	∅ recommended (cm)
Zone 1 and 2 (single zone)	9 - 11*	18
Zone 1 and 2 (Multizone)	19	22
Zone 3	13	25
Zone 4	9 - 11*	21
Zone 5	7 - 9*	16

* When using a pan with diameters smaller than the smallest diameter shown in the "∅ minimum (cm)" column, it may not be detected.

Bear in mind the following:

- Do not exceed the limits of the zones printed on the hob.
- Do not cover the control panel.
- Do not place the pans next to the edges of the glass.
- If you intend to use a griddle or a long pan in zones **1** and **2** in Multizone mode, it is recommended to use one with a maximum size of 22 x 36 cm and a minimum size of 19 x 19 cm.

Cookware suitable for use in induction cooking

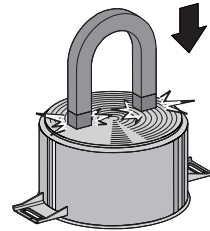

Cookware used on the induction cooking surface must be made of metal, with magnetic properties and a sufficiently large base.

Suitable cookware:

- Enamelled steel cookware with thick bases.
- Cast iron cookware with an enamelled base.
- Cookware in multilayer stainless steel, ferritic stainless steel and aluminium with a special base.

Unsuitable cookware:

- Copper, stainless steel, aluminium, fireproof glass, wood, ceramic and terracotta cookware.



To see whether the pan is suitable, bring a magnet close to the bottom: if it is attracted, the pan is suitable for induction cooking. If you do not have a magnet, you can put a small amount of water in the pan, place it on a cooking zone and start the hot plate.

Limiting the cooking duration

The hob has an automatic device which limits the duration of use.

If the cooking zone settings are not changed, the maximum duration of operation for each zone depends on the power level selected.

When the device for limiting the duration of use is activated, the cooking zone turns off, a short alert sounds and, if the zone is hot, the residual heat symbols appear on the display.

Set power level	Maximum cooking duration in hours
1	8 ½
2	6 ½
3	5 ½
4	4 ½
5	3 ½
6	1 ½
7	1 ½
8	1 ½
9	1 ½

Protection from overheating

If the hob is used on full power for a long period, the electronics will have trouble cooling down if the room temperature is high.

If the temperature of the internal electronic components exceeds the safety threshold, the appliance will switch off automatically and "ER21" will be displayed (see "Error codes").

Advice on energy-saving

- The diameter of the base of the pan must not exceed the width of the silk-screened cooking zone.
- Pans must not be placed outside the perimeter of the hob or above the front control panel.
- When buying a pan, check whether the diameter indicated is that of the base or the top of the pan, as the top is almost always larger than the base.
- When preparing dishes with long cooking times, you can save time and energy by using a pressure cooker, which also helps to retain vitamins contained in the food.
- Make sure that the pressure cooker contains enough liquid as, if there is not enough and it overheats, this may cause damage to both the pressure cooker and the cooking zone.



- If possible, always cover saucepans with a suitable lid.
- Choose a pan suitable for the quantity of food to be cooked. A large, half-empty saucepan leads to a waste of energy.



Under certain circumstances, if the hob and the oven are being used at the same time, the maximum power limit that can be used by the electrical system might be exceeded.

Power levels

The power in the cooking zone can be adjusted to various levels. The table shows the levels suitable for various types of cooking.

Power level	Suitable for:
0	OFF setting
1 - 2	Cooking small amounts of food (minimum power)
3 - 4	Cooking
5 - 6	Cooking large quantities of food, roasting larger portions
7 - 8	Roasting, slow frying with flour
9	Roasting
P / 	Roasting / Browning, cooking (maximum power)*



* see Booster and Double Booster function

Switching the hob on and off

Keep the On/Off button  pressed in for at least 1 second to activate the hob. Press it again for at least one second to deactivate it.



If no power value is selected within a few seconds, the hob is automatically deactivated.

- The text  appears on the timer display for a few seconds, during which an independent timer can be set (see "Independent timer").
- If a power limitation has been set, the number associated with the set power will be displayed for a few seconds instead of . In this case, you can still set an independent timer by touching the timer display.

Switching on the cooking zone automatically



The hob is provided with an automatic pan sensing system, indicated by the  icon. This feature is active by default, but can be disabled via the user menu.

After switching on the hob:

- Position a pan (suitable for induction cooking and not empty) on the cooking zone you wish to use.



Use

- The button corresponding to the zone on which the pan has been placed turns on automatically and displays . The other zones cannot be activated.

If automatic pan detection is disabled,

when the appliance is switched on, the  symbol appears on the display of all the cooking zones. To activate the zones, select them via the relative display and then select the required power level.

Pan detection indication

Once a zone has been activated / selected, if the  symbol appears on the display, it means the pan is unsuitable.

The  symbol also appears if there is no pan or if the pan is removed.



Use only cookware with a perfectly flat bottom which is suitable for induction hot plates. Using cookware with an irregular bottom could jeopardise the efficiency of the heating system and prevent cookware from being detected on the hot plate.



Make sure that the pans do not cover the control panel.

Adjusting the cooking zone



After having selected/activated a cooking zone:

- Place a finger on the left-hand side of the scroll bar of the cooking zone to be used.



The power level is now .

- Move your finger to the left or right on the scroll bar to select the power level, from

 to  or activate the Booster function (see "Booster Function").

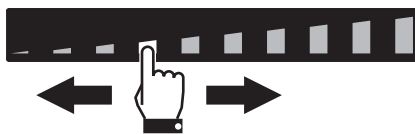

The display of the zone being used will indicate the selected power level.

Switching off the cooking zone

- Move your finger all the way to the left on the scroll bar of the cooking zone you wish to turn off.





The display of the zone being used indicates .



Hold the On/Off button  down for at least 2 seconds to switch off all cooking zones at the same time.

Quick selection



This function allows you to quickly set the cooking zones to the required power.

After switching on the hob and having selected a cooking zone:

1. Place a finger on the scroll bar at approximately the required power level.

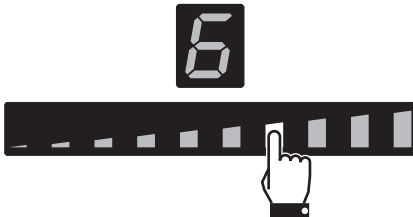

2. Move your finger to the left or right to select the required cooking power.

Booster Function



**Improper use
Danger of burns**

- Do not use the Booster and Double Booster functions to heat fats or oils as they could catch fire.



This function allows you to use the maximum available power of the cooking zone in order to bring a large amount of water to the boil rapidly.

After switching on the hob and having selected a cooking zone:

1. Place a finger on the left-hand side of the scroll bar.



The display of the cooking zone used will turn on: the power value indicated is .

2. Move your finger to the far right on the scroll bar to select power level 9.



3. Press the segment at the far right of the scroll bar.



Use

The display of the cooking zone used will show **P**. Select any other power level to deactivate the Booster function.

The Booster function can be activated quickly.

- After switching on the hob and having selected a cooking zone, press the last segment on the far right of the scroll bar twice.

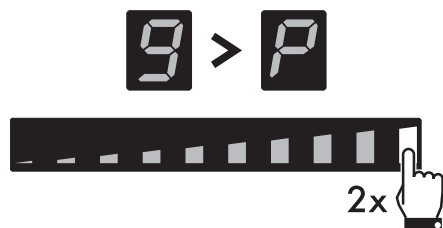

The Booster function remains active for a maximum of 5 minutes, after which the power is reduced automatically to level 9.

Double Booster Function



The Double Booster Function is available only for zones **1** and **2**.

The Double Booster function allows more power to be supplied compared to the Booster function.

After having activated the Booster function for a cooking zone, press the last segment at the far right of the scroll bar. The symbols

  and **P** will be displayed in sequence.

Multizone function



This function can be used to operate two cooking zones (front and rear) when using pans like fish kettles or rectangular pans.

After switching on the hob:

1. Place a finger on the front left and rear left cooking zone buttons at the same time.

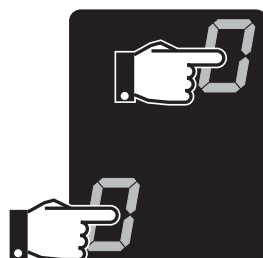

After a short beep, the  symbol will appear next to the button of the rear zone. The Multizone function is now active.



The Multizone function can be activated automatically by placing a long pan on zones **1** and **2**.

2. Use the left-hand scroll bar to set the required cooking power.

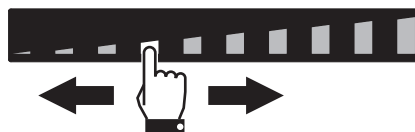



The same power level will be set for both cooking zones.



It is only possible to activate the Multizone function between zones 1 and 2.

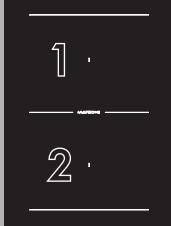

- This function automatically divides the power equally between both of the hot plates in use.
- It is not possible to activate the Double Booster function for the cooking zones on which the Multizone function is active.

If a large, oval or oblong pan is being used, make sure that it is placed in the centre of the cooking zone.

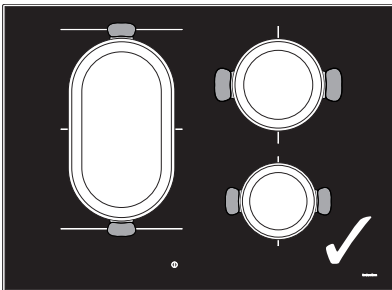

Example of correct pan position

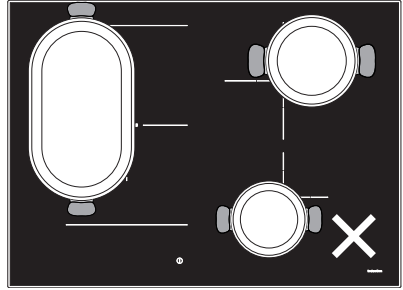

Example of incorrect pan position

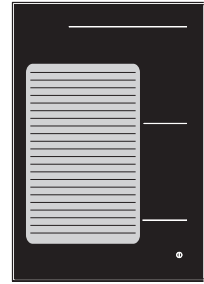
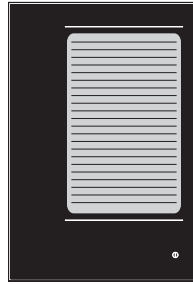

Examples of griddle position

To deactivate the Multizone function:
 Simultaneously press the buttons of the cooking zones on which the Multizone function is active. The  symbol disappears and the two zones can be regulated separately.



Use

Cooking guidelines

The table below shows the power values which can be set, together with the corresponding type of food. Settings may vary depending on the amount of food and consumer taste.

Power level	Suitable for:
1 - 2	Reheating food, keeping small amounts of water on the boil, and whipping up sauces with egg yolk or butter.
3 - 4	Cooking solid or liquid food, keeping water on the boil, defrosting deep-frozen food, cooking 2- or 3-egg omelettes, fruit and vegetables, various cooking processes.
5 - 7	Stewing meat, fish and vegetables, simmering food, making jams etc.
8-9	Cooking or frying meat, fish, steaks and liver; browning meat, fish, eggs, etc.
P - Double Booster	Deep-frying potatoes, etc., or bringing water to the boil rapidly.



Residual heat indication



Improper use Danger of burns

- Supervise children carefully as they cannot easily see the residual heat indicator. The cooking zones remain hot for a certain period of time even after they have been turned off. Make sure that children never touch the hob.

After the cooking zone has been switched off, each display shows a special symbol to indicate whether the zone is still hot, together with its indicative temperature:

-  if the temperature is between 60°C and 79°C.
-  if the temperature is between 80°C and 99°C.
-  if the temperature is 100°C or higher.

3.4 Additional functions

Rapid heating



This function is not available for power level **9** or the **Booster** and **Double Booster** functions.

The rapid heating function heats one cooking zone at maximum power for a limited time, after which it continues cooking at the set power level.



After selecting a cooking zone:

- Press and hold a power level (from **1** to **8**) for at least 3 seconds.
- The **A** symbol appears on the display of the cooking zone alternating with the selected power level.
- After the heating time has elapsed, the cooking zone reverts to the previously selected power level.

This function can be deactivated by selecting a different power level or by switching the zone off.

Warming Function



This function allows you to keep cooked food warm or to keep water on the boil.

To activate the Warming function, first turn on the hob, then:

1. Select a cooking zone.
2. Press the scroll bar between level **0** and level **1**.



3. The **L** symbol and the **ss** icon appear on the cooking zone display.

To deactivate the Warming function:

1. Select the cooking zone on which the function is active.
2. Select another power level or switch off the zone.

Independent timer



- This function is used to set a countdown timer that will emit a sound at the end of the pre-set time.
- A minimum of 1 minute and a maximum of 99 minutes can be set.

After having switched on the hob, without having selected a cooking zone:

1. Touch the inside of the timer setting area, which displays "**CL**".

2. **0 -** appears and the **G** icon flashes on the display.

3. Select the minutes using the scroll bar



(e.g. **-5**). If no selections have been made for a few seconds, a 5-minute timer can be started.

4. Once selected, the minutes digit flashes briefly and then the display allows you to

select the tens of minutes (**05**).

5. When the digit on the left stops flashing, the tens of minutes (e.g. **15**) can be selected using the same procedure.

6. After a few seconds, the timer will start the countdown.



Use

- When the time elapses, a series of beeps will be emitted and the timer display will start to flash. Press the timer display to deactivate the buzzer.



Using the independent timer does not switch off the cooking zones, it only informs the user when the set minutes have elapsed.

Timed cooking



- This function is used to program the automatic switch-off of a cooking zone at the end of a period of time.
- A minimum of 1 minute and a maximum of 99 minutes can be set.
- Timed cooking can be activated on multiple zones at the same time.

The timed cooking function can be activated after a cooking zone has been switched on:

- Select a power level.
 - Follow the same procedure as for an independent timer.
- The  symbol appears above the cooking zone display to indicate that the zone is timed.
- Timed cooking will start a few seconds after the last selection.
 - When the time elapses, a series of beeps will be emitted. This can be deactivated by pressing the timer area.

Modifying and deactivating the independent timer



If you modify a timer that has already been started, it has to be reset from the beginning.

- Activate the hob using the  button.
- Press the timer display to reset the independent timer following the relative instructions (see "Independent timer"). To reset the timer, simply set both digits of the timer to zero.

Modifying and deactivating timed cooking



- Activate the hob using the  button.
- Select the timed cooking zone to modify.
- Press the timer display to reset the countdown following the relative instructions (see "Independent timer"). To reset the timer, simply set both digits of the timer to zero.



Recall Function

i This is used to restore some functions that have already been started after the appliance has been switched off unintentionally.

If the appliance is switched off unintentionally, carry out the following procedure within 6 seconds:

1. Switch on the appliance.
 - The  icon starts to flash.
2. Then immediately press the segment of the scroll bar directly below the  icon to restore the previously active functions.

i This function restores the cooking zone, timer and rapid heating functions. No other functions will be restored.



3.5 Special functions

Grill Function

i This function is used to automatically activate the Multizone function for the left zones only. It is used when using a griddle or cooking with long pans.

To activate the Grill function:

1. Place a griddle or a long pan on the left zones.
2. Press the  button.

The  symbol appears on the front zone display and the  symbol appears on the rear zone display. The scroll bar will be set automatically to level **9**. (preheating stage)



After three minutes of operation, the power will be reduced to level **7**.

Press the  button and use the scroll bar to modify the power level at any time.

Press the  button to deactivate the Grill function.

Auto-Vent 2.0 function

- i**
- This function allows you to control the speed of the hood extractor fan via a wireless connection.
 - The hood must be designed to use the Auto-Vent 2.0 function.
 - The connection is always unidirectional, from the hob to the hood: it is not possible to control the hob via the hood.

The Auto-Vent 2.0 function is disabled by default, but can be enabled from the user menu. Once enabled, the  button always remains dimly lit.



Use

This function has an automatic and a manual mode:

- Automatic mode (default), adjusts the hood extractor fan speed according to the total power of the appliance (see "User menu" - option **U8**)
- Manual mode allows you to adjust the extractor fan speed by pressing the  button.

After switching on the hob, to activate manual mode:

1. Press the  button, which will light up at full brightness.
2. Each subsequent press of the button increases the hood fan speed according to a cyclic sequence with 5 levels of adjustment, from 0 (off) to 4 (maximum speed).

To go back to manual mode, the appliance has to be switched off and on again.



Refer to the hood manual for more detailed information.

3.6 Settings menu

The settings menu allows you to modify some of the operating characteristics of the appliance and allows you to

With the appliance switched on, press the



button to access the settings menu.

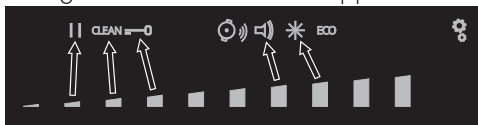

The scroll bar and all the icons of the settings that can be modified appear:



Individual settings can be selected using the segment of the scroll bar that is most directly below it.

Press the  button again to exit from the menu.





The  and  icons refer to functions that can only be modified via the user menu.

Pause function





This function pauses the operation of all the cooking zones and the timer.

To activate the Pause function:

1. Switch on at least one cooking zone.
2. Access the settings menu.
3. Press the segment of the scroll bar below the  icon. The  symbol appears on the cooking zone displays.



To deactivate the Pause function:

1. Access the settings menu.
2. Press the segment of the scroll bar below the  icon. The  symbols disappear and the appliance resumes the previous functions.



- The cooking time limitation, the residual heat indicators and the control lock function remain enabled during the Pause function.
- The pause function can be maintained for a maximum of 10 minutes, after which the appliance switches off.
- When the power comes back on after a power failure, the pause function will be deactivated.

Clean Function



Improper use Danger of burns

- When this function is active, take extra care when removing dirt if the glass surface is hot.





This function pauses the appliance for 1.5 seconds, during which it is possible to remove dirt or stains.

At least one cooking zone must be active in order for the Clean function to be used:

1. Access the settings menu.
2. Press the segment of the scroll bar below the  icon.
3. A 15-second countdown appears on the timer display, after which the appliance resumes with the previous settings.



Controls lock





This function allows you to disable all the buttons of the appliance, except for the  and  buttons.

This is useful when cleaning the appliance and to prevent functions being activated by mistake.

To activate the control lock:

1. Access the settings menu.
2. Press the segment of the scroll bar below the  icon. The  symbol appears on the display of all the cooking zones.

To deactivate the control lock:

1. Access the settings menu.
2. Press the segment of the scroll bar below the  icon. All the  symbols disappear.



Use

Button sound volume

i Allows you to adjust the volume of the sounds associated with pressing the buttons.

1. Access the settings menu.
2. Press the segment of the scroll bar below the  icon.
3. Use the scroll bar to select the required volume.

Display lighting

i Allows you to adjust the brightness of the displays.





1. Access the settings menu.
2. Press the segment of the scroll bar below the  icon.
3. Use the scroll bar to select the required level of brightness.

3.7 User menu

The user menu allows you to modify the operating characteristics of the appliance. The user menu contains 9 options that can be modified. Each option is indicated on the display with the letter "U", which alternates with a progressive number.

Option	Description
U0	Appliance power limitation (kW) - Change by the installer only
U1	Option disabled
U2	Button volume
U3	Timer alarm volume
U4	Display brightness
U5	Timer animation
U6	Automatic pan detection
U7	Timer alarm duration
U8	Hood fan configuration
U9	Auto-Vent 2.0 function

Accessing the user menu

1. If the hob is off, switch it on using the On/Off button .
2. Press  again within 3 seconds to switch it off; the  button starts to flash.
3. Press and hold .

i The  button continues to flash when you access the user menu.



4. The following appear on the cooking zone displays:

4 cooking zones models:





5 cooking zones models:



Press all the buttons of the cooking zones in sequence in a clockwise direction starting from the front left (1). Every effective touch will be confirmed by a beep.

 If the buttons are pressed in the incorrect order, the procedure for accessing the menu has to be repeated from step 3.

5. Release the  button.

The menu has been accessed and the  symbol alternating with the number  (option **U0** - Power limitation) appears on the display of the rear left zone.

The total power of the appliance can be modified in steps of 0.1 kW (function **Eco-Logic Advance**).

The timer display indicates the default power setting (in kW): .

Press the timer display to enable changes to the power settings. Then press the left half of the scroll bar to decrease the power or the right half to increase it. Keep the button pressed to reach the required setting more quickly.

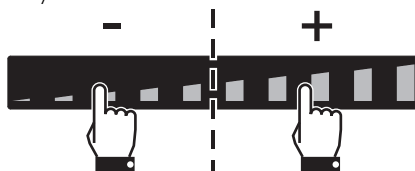

 If you set a power of less than 7.4 kW, the **ECO** icon will appear when the appliance is switched on again.

- Press the  symbol to go back to selecting the options (rear left zone display).
- Press the segments of the scroll bar to select an option.



 For technical reasons, the second segment from the left (option **U1**) is disabled. Interacting with this option will have no effect.





Use

- After selecting an option, press the front left display to modify it.



i According to the adjustment range of each option, the scroll bar will show only those segments that correspond to the adjustments available for each option.

User options

i Options **U2** and **U4** can also be modified via the settings menu (corresponding to icons  and  respectively).

Option **U2** modifies the volume of the button sounds; 4 sound levels can be selected using the scroll bar.

- **0**: minimum volume.
- **3**: maximum volume.

 The sound associated with the  button and the sounds associated with error messages cannot be modified.

Option **U3** modifies the volume of the alarm when the timer has ended. 4 levels can be selected (both for the independent timer and for timed cooking).

- **0**: minimum volume.
- **3**: maximum volume.

Option **U4** modifies the brightness of the display. 10 levels can be selected.

- **0**: maximum brightness.
- **9**: minimum brightness.

Option **U5** allows you to modify the type of animation of the seconds countdown of the independent timer and timed cooking, from 59 to 0 seconds.

i The seconds countdown is displayed when the timer is set for 1 minute.

- **0**: animation 1.
- **1**: animation 2.

Option **U6** allows you to activate or deactivate the automatic pan detection function. (see "Switching on the cooking zone automatically").

- **0**: automatic detection off.
- **1**: automatic detection on.

Option **U7** specifies the duration of the alarm when the timer has ended. 3 levels can be selected:

- **0**: alarm duration 120 seconds.
- **1**: alarm duration 10 seconds.
- **2**: alarm disabled.



Option **U8** allows you to activate the Auto-Vent 2.0 function in automatic mode. 8 levels can be selected. The following table summarises the possible settings:

Setting level	Hood lighting	Hood fan speed		
		Delicate cooking	Medium cooking	Intense cooking
0	off	off		
1	on	off		
2 - 4 - 6	on	off	speed 1	speed 2
3 - 5 - 7	on	speed 1	speed 2	speed 3

Refer to the following table to choose the most suitable setting level according to the power limitation of the appliance:

Setting level	Power limitation
2 - 3	up to 4 kW
4 - 5	from 4 to 5 kW
6 - 7	from 5 to 7.4 kW



If you select a higher power level compared to the one that has been set, it may not be possible to select some of the hood fans speeds.

Option **U9** allows you to activate or deactivate the Auto-Vent 2.0 function:

- **0**: function off.
- **1**: function on.

Exiting the user menu

There are two ways to exit from the user menu:

1. Press the  button. Any modifications will be discarded and the hob will be switched off.

Or

2. Press and hold the On/Off  button for at least 2 seconds. The modifications will be saved and the hob will be switched off.

3.8 Error codes

If the appliance malfunctions or operates incorrectly, the associated error code appears on the cooking zones display. The error codes always begin with "E.." or "Er..", followed by a number.

The following error codes can be corrected without having to contact the Technical Support Service.

- **Er03**: Remove any materials or pans from the area of the front control panel.
- **E2**: Make sure that the pans are suitable for induction cooking and that they are not empty; allow the appliance to cool down.



If these error codes appear frequently, please contact the Technical Support Service.

For all other errors, make a note of the code, if possible, and contact Technical Support.



4 Cleaning and maintenance

4.1 Instructions



Improper use

Risk of damage to surfaces

- Do not use steam jets to clean the appliance.
- Do not spill sugar or sweet mixtures on the hob during cooking.
- Do not place materials or substances that could melt (plastic or aluminium foil).
- Keep sensor buttons clean at all times and do not rest any object on them.
- Do not use cleaning products containing chlorine, ammonia or bleach on parts made of steel or that have metallic surface finishes (e.g. anodizing, nickel- or chromium-plating).
- Do not use abrasive or corrosive detergents (e.g. scouring powders, stain removers and metallic sponges) on glass parts. Use wooden or plastic utensils.

4.2 Cleaning the surfaces

To keep the surfaces in good condition, they should be cleaned regularly after use. Let them cool first.

4.3 Ordinary weekly cleaning

Clean and maintain the hob once a week using an ordinary glass cleaning product. Always follow the manufacturer's instructions. The silicon in these products creates a protective, water-repellent membrane which also resists dirt. All marks stay on the membrane and can therefore be removed easily. After cleaning, dry the surface with a clean cloth. Make sure that there is no detergent left on the cooking surface as it will undergo a corrosive reaction when heated up and could modify the structure of the cooking surface.

4.4 Food stains or residues

Light coloured marks from pans with aluminium bases can be easily cleaned off with a cloth moistened in vinegar.

Remove any burnt-on residues after cooking; then rinse with water and dry thoroughly with a clean cloth.

Dirt which may have fallen on the hob while cleaning lettuce or potatoes can scratch the hob when moving pans.

Consequently, remove any dirt from the cooking surface immediately.



Changes in colour do not affect the operation and stability of the glass. These are not alterations to the material of the hob but just residues which have not been removed and have then carbonised.

Shiny surfaces can form due to the bases of pans, especially aluminium ones, rubbing on the surface, and due to the use of unsuitable detergents. They are difficult to remove using conventional cleaning products. It may be necessary to repeat the cleaning process several times. Use of corrosive detergents or rubbing of pan bases can wear away the decoration on the hob over time and contribute to the formation of stains.

4.5 What to do if...

The hob does not work:

- Make sure that the hob is connected and that the main switch is turned on.
- Make sure that there is no power failure.
- Make sure that the fuse has not blown. In this case replace the fuse.
- Make sure that the circuit breaker of the residential electrical system has not tripped. In this case, reset the circuit breaker.

The cooking results are unsatisfactory:

- Make sure that the cooking temperature is not too high or too low.

The hob smokes:

- Let the hob cool down and clean it once cooking is complete.
- Make sure that the food has not spilled out of the pan and use a larger cooking vessel, if needed.

The fuses blow or the circuit breaker of the residential electrical system trips repeatedly.

- Call Technical Support or an electrician.

There are cracks or fissures in the hob:

- Turn off the appliance immediately, disconnect the power supply and contact Technical Support.



Installation

5 Installation

5.1 Electrical connection



**Power voltage
Danger of electrocution**

- Have the electrical connection performed by authorised technical personnel.
- Use personal protective equipment.
- The appliance must be connected to earth in compliance with electrical system safety standards.
- Disconnect the mains supply.
- Do not pull the cable to unplug the appliance.
- Use cables withstanding a temperature of at least 90°C.
- The tightening torque of the screws of the terminal supply wires must be 1.5 - 2 Nm.

General information

Check the grid characteristics against the data indicated on the plate.

The identification plate bearing the technical data, serial number and brand name is visibly positioned on the appliance.

Do not remove this plate for any reason.

Perform the ground connection using a wire that is 20 mm longer than the other wires.

The appliance, depending on the model, can be connected as follows:

80 cm models with 4 cooking zones:

- 220-240 V / 380-415 V 2N~

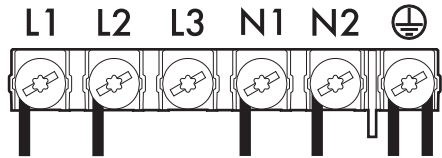

6 x 1.5 mm² six-core cable.

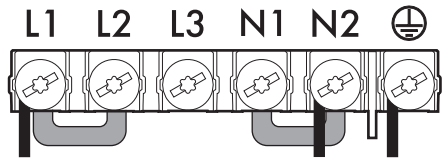

3 x 6 mm² three-core cable.

80 cm models with 5 cooking zones and 90 cm models:

- 380-415 V 3N~

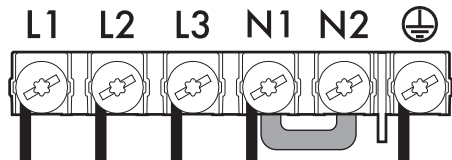

5 x 2.5 mm² five-core cable.

- 220-240 V 3~/ 380-415 V 2N~

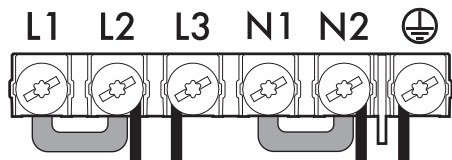

4 x 4 mm² four-core cable.



- 220-240 V 1N~

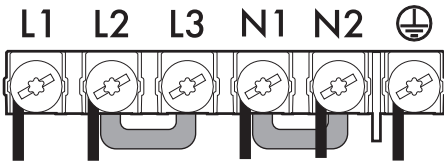

5 x 4 mm² five-core cable



For all types of connection, use the jumper provided.

Fixed connection

Fit the power line with an all-pole circuit breaker in compliance with installation regulations. The circuit breaker should be located near the appliance and in an easily reachable position.



Run the power cable in the rear part of the unit. Make sure that it does not come into contact with the lower part of the hob or a built-in oven below it.



Be careful when connecting additional electrical appliances. Connection cables must not come into contact with hot cooking zones.

Testing

At the end of installation, carry out a brief inspection test. If the hob fails to operate, after checking that you have carried out the instructions correctly, unplug the appliance and contact Technical Support.

5.2 Instructions for the installer

- Do not bend or trap the power cable.
- The appliance must be installed according to the installation diagrams.
- If the appliance does not work correctly after having carried out all the checks, contact your local Authorised Service Centre.
- Once the appliance has been installed, please explain to the user how to use it correctly.

5.3 Safety instructions



Heat production during appliance operation
Risk of fire

- Check that the carcass material is heat resistant.
- Check that the carcass has the required openings.
- Do not obstruct the ventilation grille in front of the product during mounting.

Veneers, adhesives or plastic coatings on adjacent furniture should be temperature-resistant (>90°C), otherwise they might warp over time.

The minimum clearance between exhaust hoods and the cooking surface must be at least the distance indicated in the exhaust hood installation instructions.

The minimum clearances must also be respected for the edges of the hob on the back as indicated in the mounting illustrations.



Installation

5.4 Power limitation

The appliance is factory set to use the maximum available power: 7.4 kW.



The maximum power of the appliance can be regulated via the user menu.

5.5 Section cut from the countertop



The following operation requires building and/or carpentry work and must therefore be carried out by a competent tradesman. Installation can be carried out on various materials such as masonry, metal, solid wood or plastic laminated wood as long as they are heat resistant (>90°C).

Create an opening with the dimensions shown in the figure in the countertop of the piece of furniture.

Hob seal

To prevent leakage of liquid between the frame of the hob and the countertop, place the adhesive seal provided along the entire outer edge of the hob before assembly.

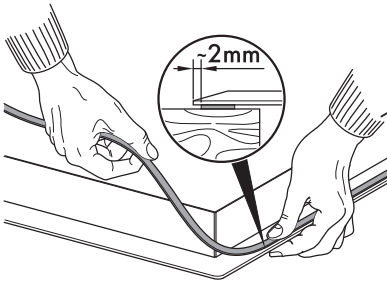

Do not use silicone to secure the hob. This would make it impossible to remove the hob, if necessary, without damaging it.

Overall dimensions (mm)

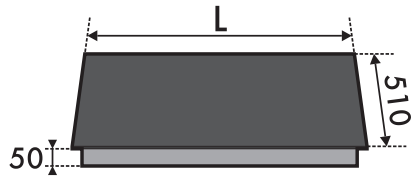

Semi-flush mounting dimensions (mm)

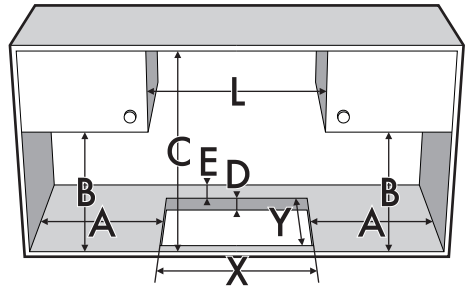

L	X	Y
800	730 ÷ 750	480 ÷ 490
900	839 ÷ 844	478 ÷ 482

A	B	C	D	E
min. 50	min. 460	min. 750	20 ÷ 60	min. 50



Flush mounting dimensions (mm)

For this type of mounting, you have to make an additional cut at the edges of the recess if you wish to install the hob flush with the countertop.

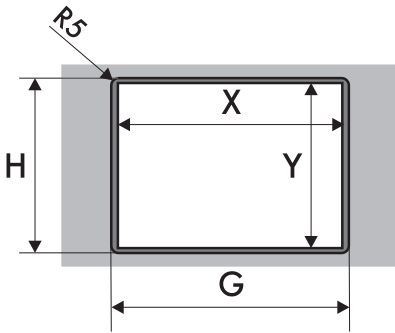
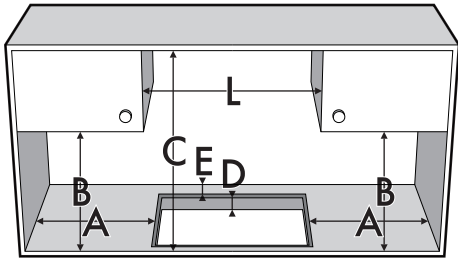

A	B	C	D	E
min. 50	min. 460	min. 750	20÷60	min. 50
L	X	Y	G	H
800	730 ÷ 750	480 ÷ 490	803	513
900	840	478 ÷ 482	903	513

1 = Electrical connection

After laying the adhesive seal (A) on the glass surface and after positioning and securing the hob, fill the edges with insulating silicone (B) and wipe away any excess. In the event the hob needs to be removed, cut the silicone using a cutter before attempting to remove it (C).

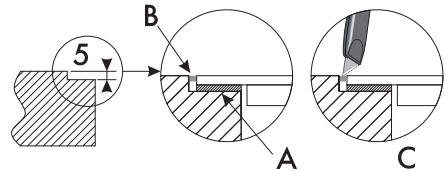

5.6 Mounting

Over built-in oven unit



If installed on top of an oven, the latter must be equipped with a cooling fan.

The clearance between the hob and the kitchen units or other built-in appliances must be enough to ensure sufficient ventilation and air discharge. If installed above an oven, a space must be left between the bottom of the hob and the top of the appliance installed below.

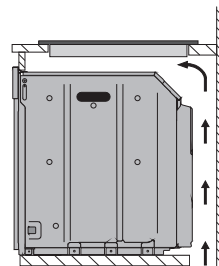

opens on bottom



Installation

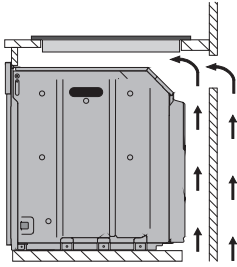

opens on bottom and on rear

On top of an empty kitchen unit or drawers

If there are other pieces of furniture (lateral walls, drawers, etc.), dishwashers or fridges under the hob, a double-layer wooden base must be installed at least **20 mm** from the bottom of the hob to avoid any accidental contact. It must only be possible to remove the double-layer base using suitable equipment.

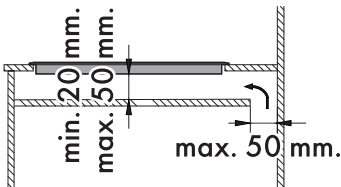
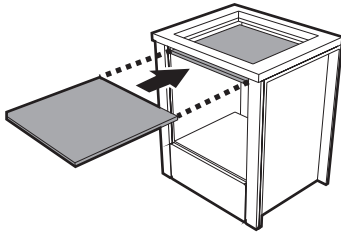

opens on bottom

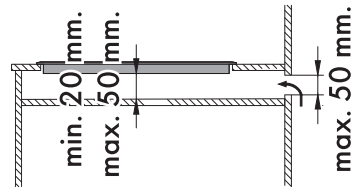

opens on rear



Failure to install the double-layer wooden base exposes the user to possible accidental contact with sharp or hot parts.

Ventilation

The illustrations below show two examples of installation suitable for proper ventilation and one example of incorrect installation to be avoided.

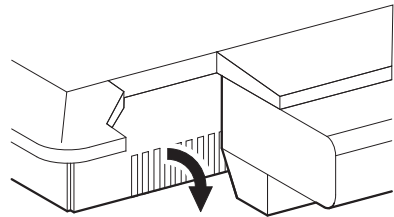
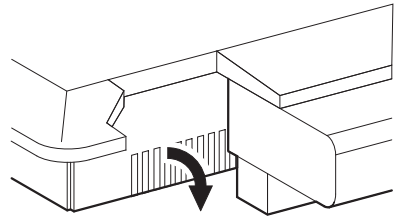

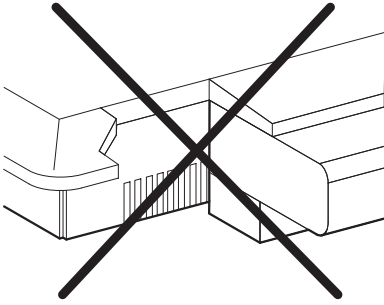

Spring clips

To ensure the hob is fixed and centred as accurately as possible, the clips provided must be positioned as described below:

1. Fit the clips by gently pressing them horizontally into the appropriate space.

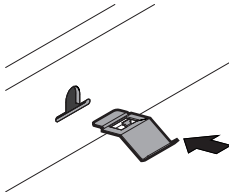

2. Then turn them upwards to fix them in place.

